

ASSEMBLY AND INSTALLATION INSTRUCTIONS

T0347

WARNING: TO AVOID RISK OF ELECTRICAL SHOCK, BE SURE TO SHUT OFF POWER BEFORE INSTALLING OR SERVICING THIS FIXTURE.

NOTES: 1. Before installing, consult local electrical codes for wiring and grounding requirements.
2. READ AND SAVE THESE INSTRUCTIONS.

Hardware Package (included):

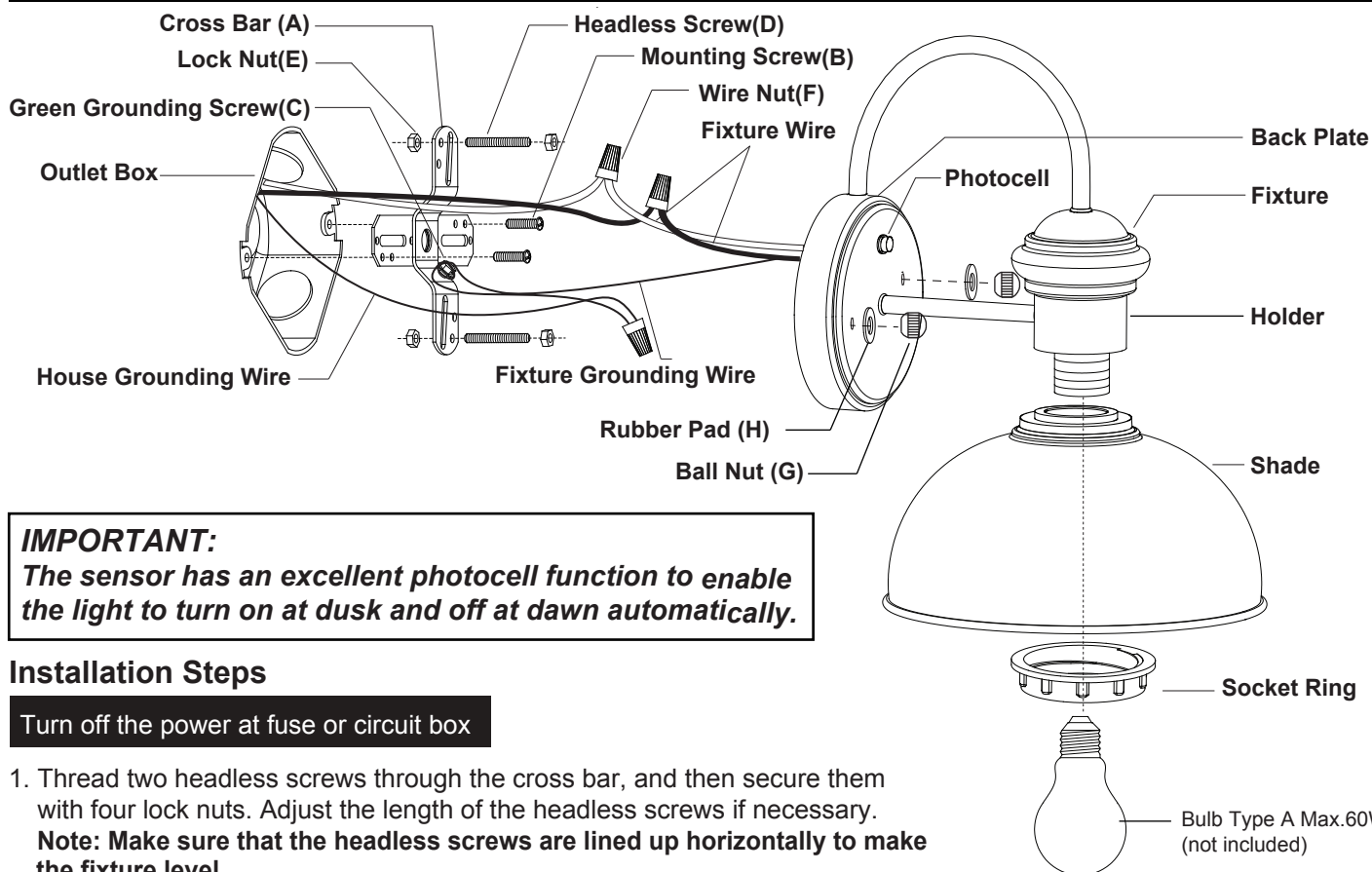
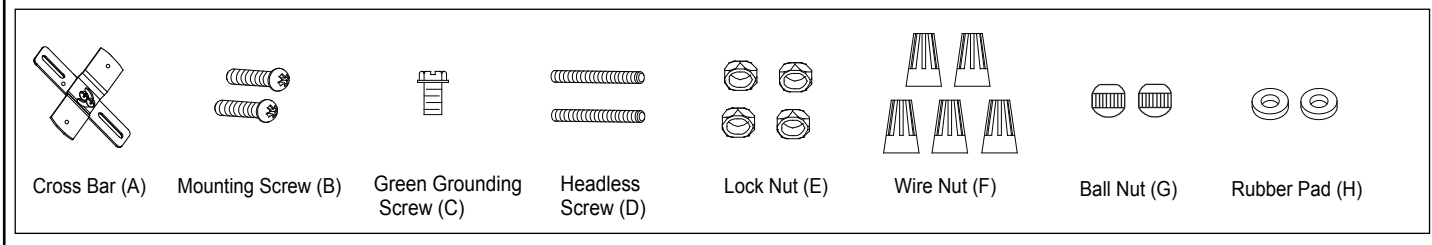

IMPORTANT:

The sensor has an excellent photocell function to enable the light to turn on at dusk and off at dawn automatically.

Installation Steps

Turn off the power at fuse or circuit box

1. Thread two headless screws through the cross bar, and then secure them with four lock nuts. Adjust the length of the headless screws if necessary.
Note: Make sure that the headless screws are lined up horizontally to make the fixture level.
2. Attach the cross bar to the outlet box by using two mounting screws.
3. Pull out the source wires from the outlet box. Make wire connections using wire nuts as follows:
---Connect the hot wire (usually black insulation) from the fixture to the black wire from the power source.
---Connect the neutral wire (usually white insulation) from the fixture to the white wire from the power source.
---Attach the fixture grounding wire (usually green insulation or bare wire) to the cross bar with the green grounding screw, and then connect it to the house grounding wire with the wire nut.
Carefully put the wires back into the outlet box.
4. Attach the fixture body to the cross bar by inserting headless screws into holes on back plate, and then secure it with two rubber pads and two ball nuts.
NOTE:With silicone caulking compound, caulk completely around where the back plate meets with the wall surface to prevent water from seeping into the outlet box.
5. Attach shade to holder, then secure it with socket ring.

6. Install a bulb (not included). Check relamping label at socket area or packaging for maximum allowed wattage.

Turn on the power at fuse or circuit box.

Operation the Unit Without Photocell

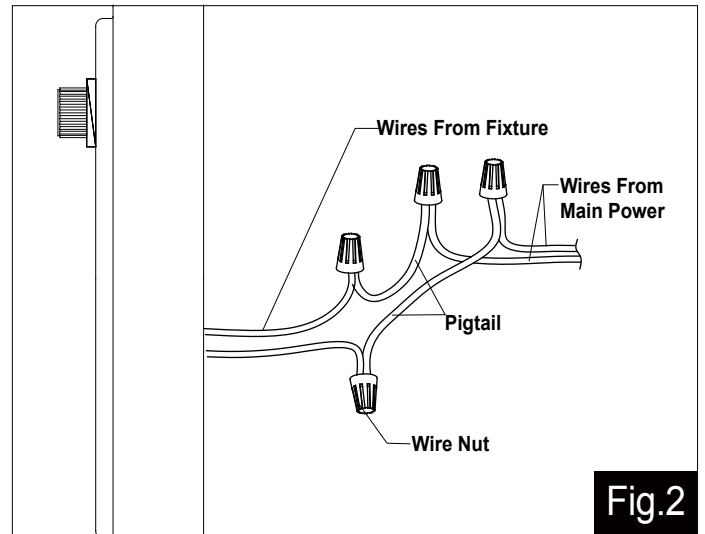
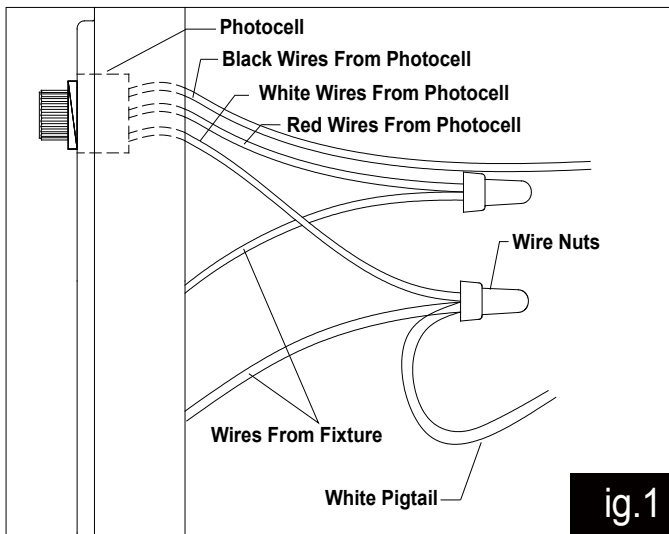

1. Turn off the power at the main fuse or circuit breaker box before starting installation.
2. Loosen the wire nuts connected with the wires from photocell. (See Fig.1)
 - Note: Do not move the photocell to prevent water from seeping into the outlet box.**
3. Take a white pigtail and black pigtail and make wire connections using wire nuts: (See Fig.2)
 - a. The black wire from the fixture to one end of the black pigtail.
 - b. The white wire from the fixture to one end of the white pigtail.
 - c. The other end of the black pigtail to the black wire from the power source.
 - d. The other end of the white pigtail to the white wire from the power source.
 Put all wires back into the back plate of the fixture.

Turn on the power at fuse or circuit box

The following parts are available for re-order if damaged or missing.

Spare Parts List:

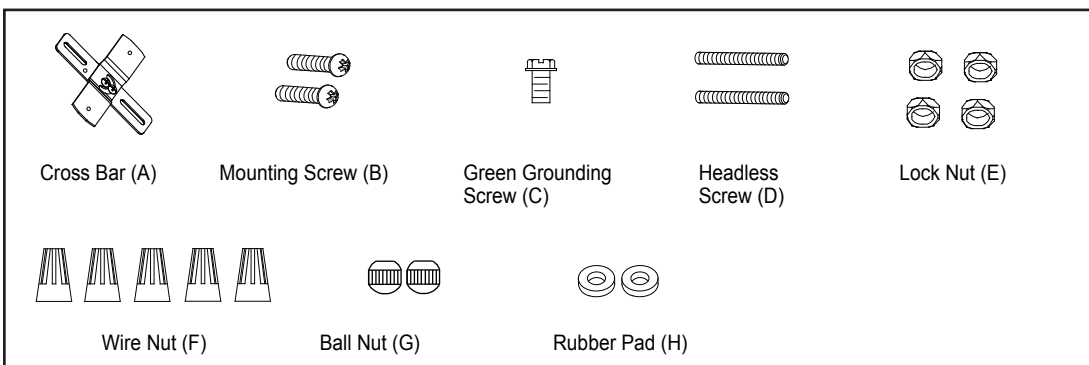

→ Assembly Kit 5579MM (1SET)

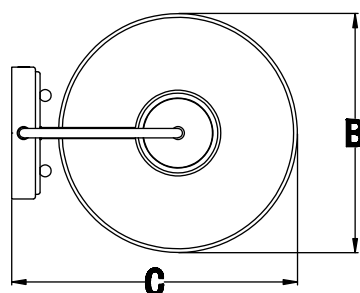
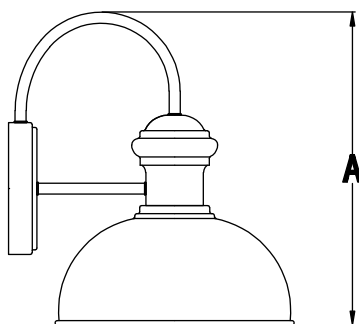

A:15"
B:13"
C:15.25"