

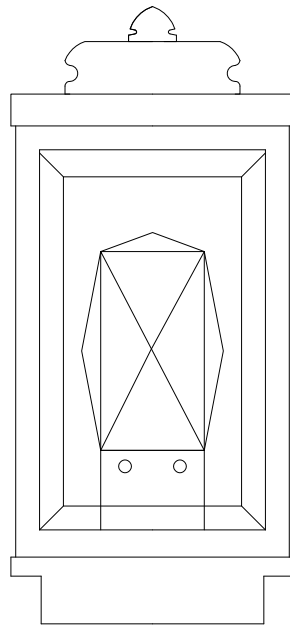

PRODUCT NAME: Mandeville 2-Light
ITEM NUMBER: 53524

Please consult your electrician for hanging fixture and wiring.



To prevent water intrusion, caulk around back-plate where fixture meets the wall using outdoor silicone sealant. Leave a small gap at the bottom to allow moisture to exit.

"This fixture is designed to dim with an Electronic Low Voltage dimmer. Dimming levels will vary by dimmer.

Below is a List of Recommended Dimmers:

* Lutron MACL-153M

* Leviton IPL06-10Z

Due to inrush current, wattage should not exceed 150 Watts of product for a 600 Watt dimmer."

13W AC LED

PRODUCTS ARE NOT INENDED
FOR COMMERCIAL USE.

MADE IN CHINA
Page 1 of (2)



PRODUCT NAME: Mandeville 2-Light
ITEM NUMBER: 53524

CAUTION: Before starting the installation, disconnect the power by turning off the circuit breaker or by removing the fuse at the fuse box.

Carefully unpack and identify all parts before assembly

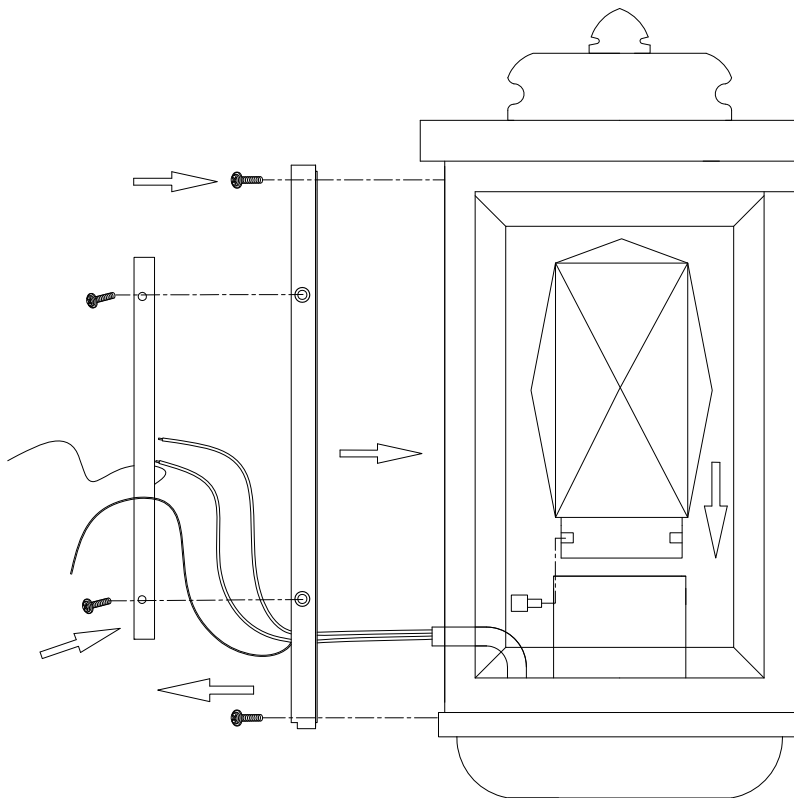

Installation Procedures

1. Remove mounting bracket from fixture and install to electrical box.
2. Remove backplate from fixture.
3. Install beveled crystal onto base and secure with finials.
4. Install fixture to backplate. Carefully run wire through backplate and stainless steel backing. Secure using screws provided.
5. Wire fixture to wires in outlet box. Copper wire is for Ground.
6. Attach fixture to mounting bracket and tighten screws on the side so fixture meets wall.
(For outdoor use, caulk fixture with silicone sealant)